

# Broquet

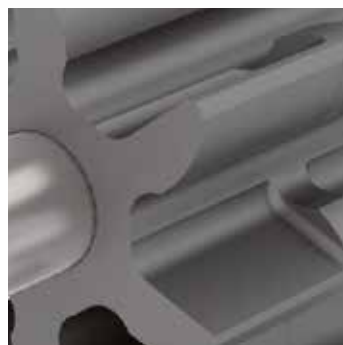

SOLUTIONS FOR THE CHOCOLATE INDUSTRY

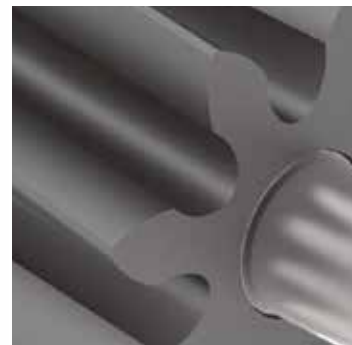
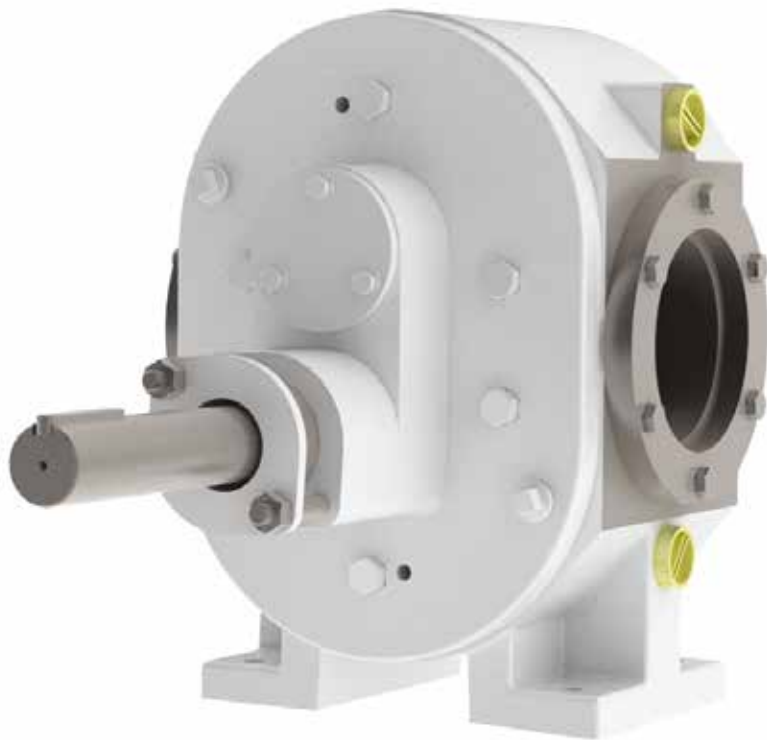

*Viscous liquid solutions*

# 25

years of experience and a history of working with leading names in chocolate means that a BROQUET pump is the most suitable product.

Its technology fulfills the main requirements when it comes to pumping chocolate: respect of the raw material and preventing any risk of burning or polluting the chocolate.

Present in output systems from grinding mills, melting facilities or presses, used for draining conches, feeding pouring units or tempering machines, BROQUET pumps have been designed to bring chocolate and candy makers, as well as bakeries, the reliability they need to properly express their know-how.

## BECAUSE YOUR RECIPES ARE COMPLEX, OUR SOLUTIONS ARE NUMEROUS

*At every stage of the chocolate process, the raw material is transformed and rheological properties of the fluid change. A universal technology could only be an approximation.*

*For optimum performance, Broquet offers a complete range of rotors adapted to the different states of the liquid, from the crushing of the cocoa bean up to any kind of chocolate recipe.*



**ROTOR TYPE F**

### HELICAL CHEVRON

This specific profile of tooth protects the pumped liquid and avoids the separation of dry and fat masses. It is designed to avoid any excessive shear of the chocolate and produce a flow with few pulses. The rotation speed is critical to the texture of the chocolate. The 7/8-tooth-rotor achieves significant flow rate with low rotation speed.

- Black, milky and white chocolate
- Praline chocolate
- Cocoa butter
- Cocoa mass up to 50 °C



**ROTOR TYPE B**

### SELF-GEARING LOBES

Usually selected for remelt, this profile is design to allow solids, such as nuts and fruits, to go through the pump and prevent grinding and risks of blockage. This rotor is also used to transfer masses with high sugar crystal content and abrasive liquids.

- Highly viscous chocolate
- Chocolate with solid ingredients
- Cocoa liquor
- Remelt, etc.



**ROTOR TYPE X**

### DOUBLE PROFILE

This new design is suitable for significant flow rates up to 30 t/h. The smart double profile ensures the transfer of a wide range of chocolates, from the highest grades to the most sweetened. It also prevents the separation of dry and fat masses.

- Black & milky chocolate
- White chocolate
- Cocoa fat, etc.

 **PATENTED MODELS**

## RELIABLE & COMPACT DESIGN

### DESIGN LAYOUT

- Few rotating elements
- 4 internal bushings sets
- No synchronizing gearbox

### DIMENSIONS

- Eco-design

## 8 MAJOR COMPONENTS ONLY

### ROTORS

The 6, 7 or 8-tooth architecture of the gearing ensures to constantly have as much internal sealing points.

### BUSHINGS

The internal bearing design means lubrication is provided by the pumped product thereby avoiding the need to add lubricants that may pollute the chocolate.

Derived from our experience in transferring liquids laden with dry matter and sugar, internal lubrication is optimized to protect against burning risks (caramel formation), important when transferring white chocolate. This expertise combined

with the research undertaken into the materials used means the bearings offer reliability and very long service life cycles.

### DYNAMIC SEAL

Only the shaft of the leading rotor is sealed using soft gland-packing as standard.

Pumps can be delivered with various brands of single or double mechanical sealing.



**ONLY BROQUET GENUINE PARTS ENSURE  
THE RELIABILITY OF YOUR PROCESS**

## PREVENTION

### INDEPENDANT HEATING JACKET

Designed for uniform heat distribution, the reheating casing is sunk into the core of the material. This new integral casing design ensures a significant reheating capacity and therefore the significant heat flow needed to quickly raise temperature levels and optimize energy consumption.

The separate integral casing guarantees the chocolate from any pollution from the heating liquid. This layout makes it possible, where necessary, to open up the pump on site, without disconnecting the heating circuit.

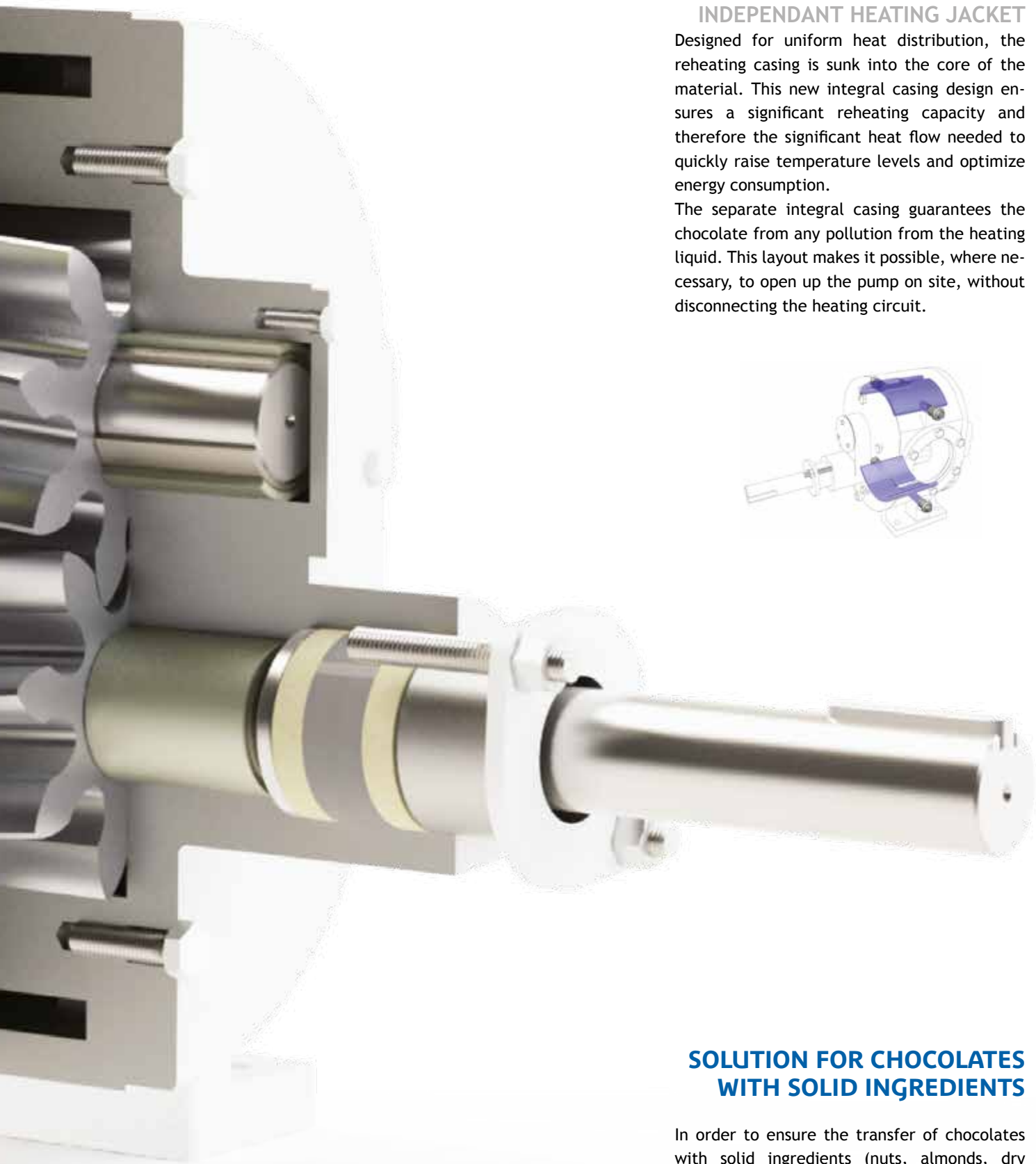

### SOLUTION FOR CHOCOLATES WITH SOLID INGREDIENTS

In order to ensure the transfer of chocolates with solid ingredients (nuts, almonds, dry fruits, ...), we have designed specific areas in rotors type «B».

# SELECTION DIAGRAM

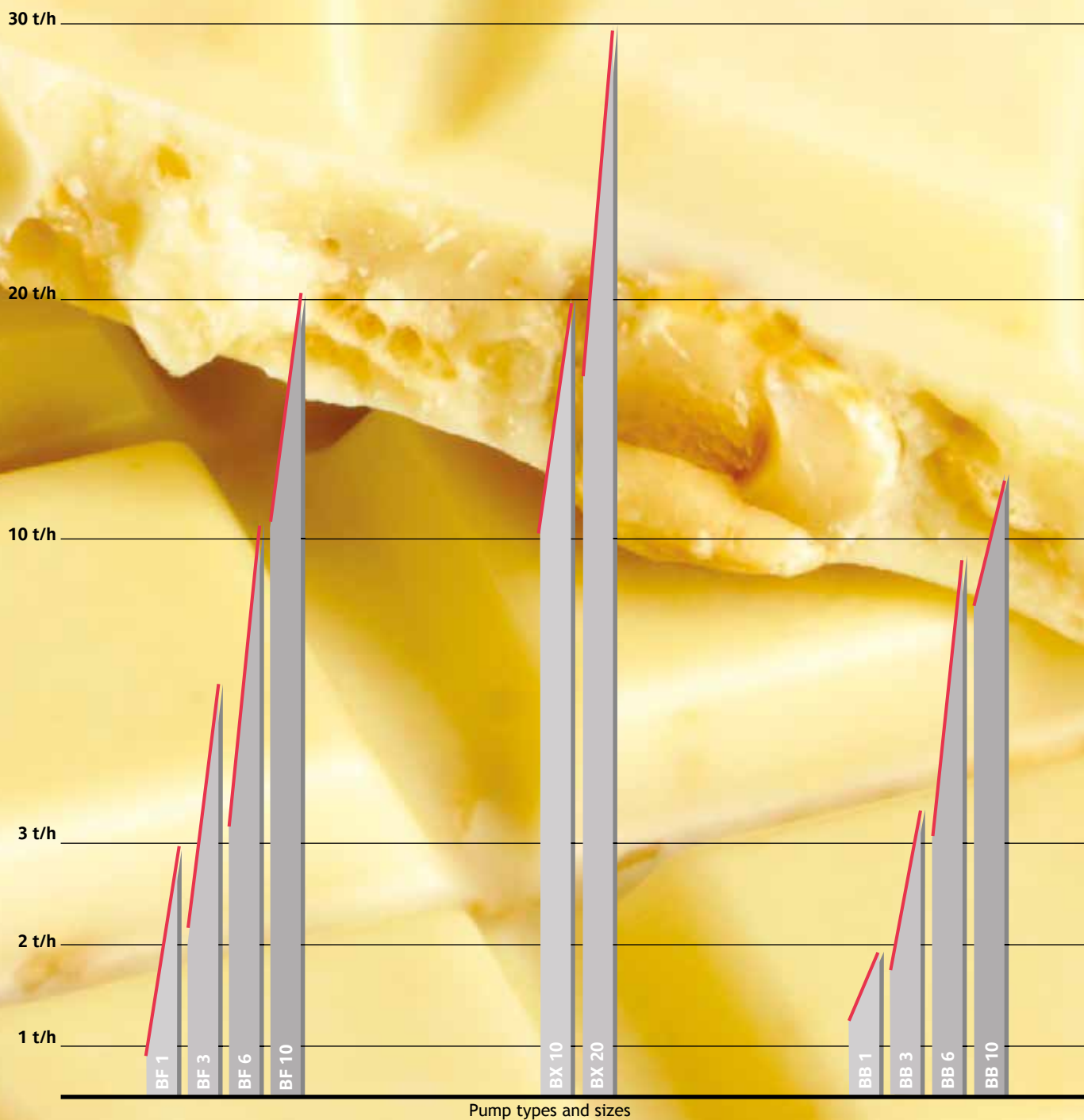

Contact us to select the right pump for your application.



ROTOR TYPE F



ROTOR TYPE B



ROTOR TYPE X

## MAIN VERSIONS

## OPTIONS

### CAST IRON PUMP



### DIMENSIONS

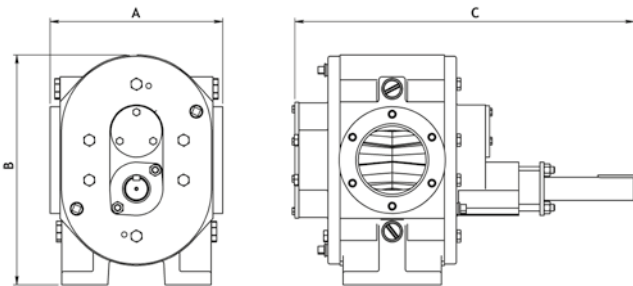

Taille	A mm	B mm	C mm	Orifices mm	Poids kg
BF1	192	233	338	Ø 77	27
BF3	234	294	403	Ø 90	53
BF6	266	345	515	Ø 109	80
BF10	266	345	594	Ø 109	116
BB10	314	424	547	Ø 115.5	130
BB20	374	514	700	Ø 170	225

### FULL STAINLESS STEEL PUMP



### BODY COATING FOR ABRASIVES LIQUIDS

#### Nickel treatment for cocoa liquor.

In order to resist to the high abrasion of the cocoa liquor at  $\pm 80^{\circ}\text{C}$ , pumps get a special coating «food approved» and the mechanical resistance of rotors is increased by using special hardness alloys.



### SAFETY AND INSTRUMENTATION

- Filter on the suction side to collect unexpected parts in the liquid.
- Sensors (temperature, pressure, flow rate)



Strainer



Filter with independent heating jacket and magnetic bars

### SPECIAL CONFIGURATIONS

According to customers requirement  
Example : pump on mobile cart





## PREFERRED SOLUTION WORLDWIDE

- A technical solution that is operational in more than 60 countries
- A network of partners, distributors and agents throughout the world

**Broquet**  **Pumps**

+33 (0)1 39 47 36 11 T  
+33 (0)1 39 47 36 19 F

[broquetpumps.com](http://broquetpumps.com)  
[info@broquetpumps.com](mailto:info@broquetpumps.com)

Georges Brière s.a. Manufacturer  
15, rue Jean Poulmarch  
95100 Argenteuil, France